

1	Description of the appliance	21
2	Safety warning	22
3	Installation	22
4	Preparing the coffee maker	23
4.1	Filling the water tank	23
4.2	Filling the container with coffee beans	23
4.3	Using the coffee maker for the first time	23
5	Preparing the coffee (using coffee beans)	24
6	Adjusting the coffee grinder	26
7	Preparing espresso coffee with ground coffee (instead of beans)	27
8	Hot water delivery	27
9	Preparing cappuccinos (using steam)	28
10	Cleaning and maintenance	29
10.1	Cleaning the coffee maker	29
10.2	Cleaning the infuser	30
10.3	Descaling	31
10.4	Setting the water hardness	32
11	Meaning of the normal operation indicator lights	33
12	Meaning of the alarm indicator lights and what to do when they are on	34
13	Problems that can be resolved before calling the service centre	35

## 1. DESCRIPTION OF THE APPLIANCE (SEE PAGE 3)

- |                                       |   |
|---------------------------------------|---|
| A. Cup warmer tray                    | M. Infuser                                    |
| B. Steam knob                         | N. Power cable                                |
| C. Steam spout                        | O. Milk frother (removable)                   |
| D. Milk frother                       | P. Milk frother nozzle (removable)            |
| E. Water tank (removable)             | Q. Measure for pre-ground coffee              |
| F. Cup support tray                   | R. Removable container for the coffee grounds |
| G. Drip tray (removable)              | S. Grinding coarseness adjustment knob        |
| H. Service door                       | T. Container for the coffee beans             |
| I. Coffee spout, adjustable in height | U. Compartment for the measure                |
| J. Control panel                      | V. Funnel for pre-ground coffee               |
| K. Bean container lid                 | Z. Mobile drawer                              |
| L. Centre lid for the ground coffee   |   |

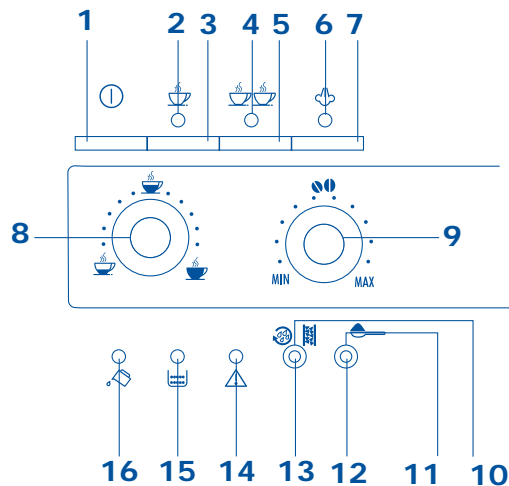

### Control panel

- |  |  |
|--|--|
| 1) On/off button   | 9) Grinding quantity selector knob (for weak, normal or strong coffee) |
| 2) 1 cup and coffee temperature OK light                 | 10) Rinse and descaling button   |
| 3) One cup button  | 11) Ground coffee button (disables the coffee grinder)                 |
| 4) 2 cup and coffee temperature OK light                 | 12) Ground coffee light (coffee grinder disabled)                      |
| 5) Two cup button  | 13) Scale alarm light  |
| 6) Steam and steam temperature OK light                  | 14) Generic alarm indicator light                                      |
| 7) Steam function selector button                        | 15) Grounds container full or absent indicator light                   |
| 8) Coffee quantity selector knob (short, normal or long) | 16) No water or water tank absent indicator light                      |

## 2 SAFETY WARNINGS

CAREFULLY READ AND KEEP THESE INSTRUCTIONS!

- This machine is designed to “make espresso coffee” and to “heat drinks”: be careful to avoid scalding from the water and steam jets or by using the machine incorrectly.
- This appliance is for household use only. All other use is considered improper and consequently dangerous.
- The manufacturer is not liable for damage caused by improper, incorrect or unreasonable use of the appliance.
- During operation, do not touch the hot surfaces of the appliance. Use the knobs or handles.
- Do not touch the appliance with damp hands or feet.
- Do not allow children or unfit persons to use the appliance unsupervised.
- Do not allow children to play with the appliance.
- In the event of breakdown or faulty operation, turn the appliance off and do not tamper with it. For repairs, contact a technical service centre authorised by the manufacturer only. Request that only original spare parts be used. Failure to respect the above may compromise the safety of the appliance.

## 3 INSTALLATION

- After unpacking, make sure the appliance is complete and undamaged. If in doubt, do not use it. Contact professionally qualified personnel.
- Packing elements (plastic bags, polystyrene etc) must not be left within reach of children as they may represent a hazard.
- Place the appliance on a work surface far away from water taps, basins and sources of heat.
- **After having positioned the appliance on the work bench, make sure that there is a free space of around 5 cm between the surfaces of the appliance and the side and rear walls and a free space of at least 20 cm above the coffee maker.**
- Never install the machine in environments where the temperature may reach 0°C or lower (the appliance may be damaged if the water freezes).
- Check that the voltage of the mains power supply corresponds to the value indicated on the appliance’s rating plate. Only connect the appliance to a power outlet with a minimum rating of 10A that is properly earthed. The manufacturer declines all liability for any accidents caused if the system is not correctly earthed.
- If the power outlet does not match the plug on the appliance, have the outlet replaced with a suitable type by qualified personnel.
- The power cable for this appliance must not be replaced by the user, in that this operation requires the use of special tools. In the event of damage, only contact a service centre authorised by the manufacturer so as to avoid any risks.
- The water hardness should be set as soon as possible, following the procedure described in chapter 10.4.

To correctly learn how to use the machine, when starting it for the first time, carefully follow the step-by-step instructions described in the following paragraphs.

## 4 PREPARING THE COFFEE MAKER

### 4.1 FILLING THE WATER TANK

- Remove the water tank (Fig.1), rinse it and fill it with fresh water, without exceeding the MAX line. When removing the tank, the milk frother must always be positioned towards the centre of the machine, otherwise the tank cannot be removed.
- Replace the tank, **pushing it all the way in**.

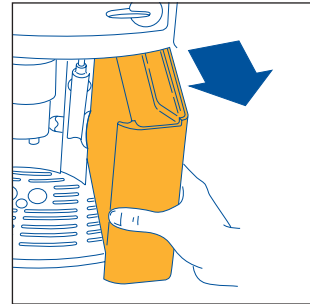

Fig.1

### 4.2 FILLING THE CONTAINER WITH COFFEE BEANS

- Open the lid on the coffee bean container (Fig.2).
- Fill the container with coffee beans.
- Close the lid.

**WARNING:** To avoid malfunctions, never introduce ground coffee, freeze-dried coffee or caramelised beans, or other objects that may damage the machine.

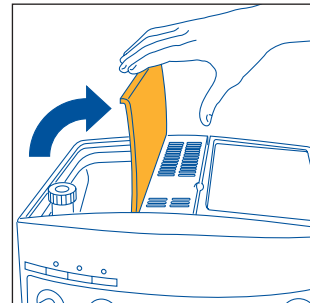





Fig.2

### 4.3 USING THE COFFEE MAKER FOR THE FIRST TIME

1. Check that the water tank is full and that power cable is plugged into the power outlet.
2. Move the milk frother towards the outside and place a cup underneath (Fig.3). Then turn the machine on by pressing the  button (Fig.4).
3. **IMMEDIATELY AFTER, WITHIN A MAXIMUM OF 30 SECONDS**, turn the steam knob anticlockwise until it stops (Fig.5) (it is normal for the machine to make some noise).
4. After few seconds, a little water will come out of the milk frother. When there is around 30cc in the cup, turn the steam knob half a turn clockwise (Fig.6) until it stops, so as to stop the water coming out.
5. Wait for the  and  lights to stop flashing and turn on steady. (When the lights are flashing it means that the machine is pre-heating, while when they are on steady it means that the machine has reached the ideal temperature for making coffee - par. 11 - points 1 and 2).  
*A few moments before the lights stop flashing the machine automatically performs a rinse cycle: a little hot water will come out of the delivery spouts and will be collected in the drip tray underneath.*  
Tip: for a hotter, short coffee (less than 60 cc), , first fill the cup with the hot rinsing water. Then leave it inside for a few seconds (before emptying it) so as to pre-heat the cup.
6. At this point, the machine is ready for use.

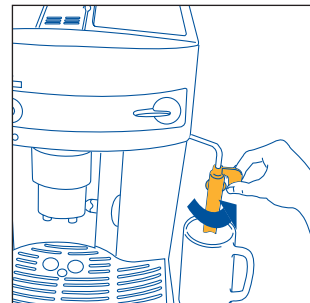

Fig.3

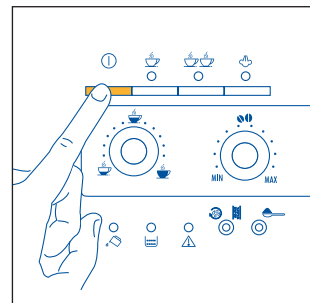









Fig.4

## 5 PREPARING THE COFFEE (USING COFFEE BEANS)

- 1) Before delivering the coffee, always make sure that the green  and  lights are on steady, that the water tank and the coffee bean container are full.
- 2) Adjust the right-hand knob (Fig. 7) to set the desired taste of the coffee. Turning the knob clockwise increases the quantity of coffee beans that the machine will grind, and thus makes the taste of the coffee stronger. When using the machine for the first time, the correct position of the knob can be found by trial and error. Make sure not to turn it too far clockwise, otherwise the coffee will be delivered too slowly (in drops), above all when preparing two cups of coffee.
- 3) Adjust the left-hand knob (Fig. 8) to set the quantity of coffee required. Turning the knob clockwise makes a longer coffee. When using the machine for the first time, the correct position of the knob can be found by trial and error.
- 4) Place one cup under the spouts to make 1 coffee (Fig. 9) or 2 cups for 2 coffees (Fig. 10). For a creamy coffee, lower the spouts to bring them as close to the cups as possible (Fig. 11).
- 5) Press the  button (Fig. 12) to make one cup of coffee or the  button (Fig. 13) to make 2 coffees. At this point the machine grinds the beans, runs a short pre-infusion cycle, a pause and then completes the delivery.  
Once the desired quantity has been reached, the machine automatically stops delivering the coffee and discharges the grounds into the special container.
- 6) After a few seconds, when both the green  and  indicator lights are on again, another coffee can be made.
- 7) To switch the machine off, press the  button. (Before switching off, the machine automatically runs a rinse cycle: a little hot water will come out of the spouts and will be collected in the drip tray underneath - be careful, to avoid being scalded). If the machine is not switched off using the  button, it will switch itself off and run a brief rinse cycle 3 hours after the last operation

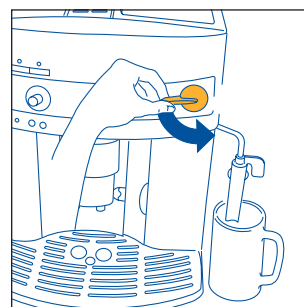

Fig.5

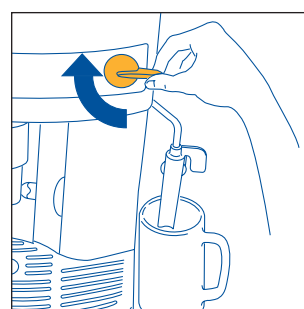

Fig.6

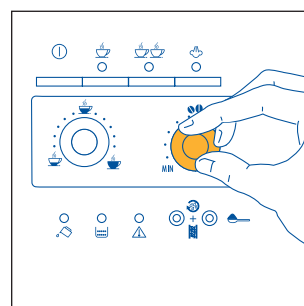

Fig.7

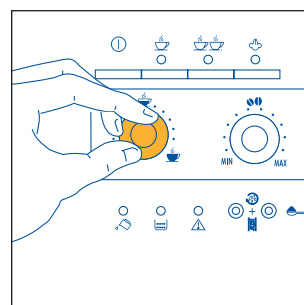



Fig.8

**NOTE 1:** If the coffee is delivered a drop at a time or not at all, turn the grinding coarseness regulator (fig. 17) one click clockwise (see para. 6). Turn a click at a time until the coffee is delivered satisfactorily.

**NOTE 2:** If the coffee is delivered too fast and is not creamy enough, turn the right-hand knob (fig. 7) clockwise. Proceed by trial and error to find the correct position of the knob. Make sure not to turn the knob too far clockwise, otherwise the delivery may become too slow (in drops), above all when making two cups of coffee. If, after several coffees, the cream is still not satisfactory, also turn the grinding adjustment knob (Fig. 17) one click clockwise (see para. 6).

### NOTE 3: Tips on making hotter coffee:

1) If, when the machine has just been turned on, a short cup of coffee is required (less than 60cc), use the hot rinsing water to pre-heat the cups (see the suggestion in par. 4.3, point 5). 1) If, when the machine has just been turned on, a short cup of coffee is required (less than 60cc), use the hot rinsing water to pre-heat the cups (see the suggestion in par. 4.3, point 5). If, on the other hand, more than 2/3 minutes have elapsed since the last coffee was made, before preparing another coffee the infuser must be pre-heated, pressing the   button (Fig. 14).

Then let the water flow out into the drip tray underneath, or alternatively use this water to fill (and then empty) the cup to be used for the coffee, so as to pre-heat it.

2) Unless preheated, do not use cups that are too thick, as they will absorb too much heat.

3) Use cups that have been previously heated by rinsing them with hot water or alternatively by leaving them for at least 20 minutes on the cup warmer tray on top of the machine with the appliance on.

**NOTE 4:** while the machine is making the coffee, the delivery can be stopped at any time by pressing the ☺ button (Fig. 12) or ☺☺ button (Fig. 13), as previously selected.

**NOTE 5:** as soon as delivery is complete, to increase the quantity of coffee, simply press and hold the ☺ button (Fig. 12) or ☺☺ button (Fig. 13), as previously selected, until reaching the desired quantity (this operation must be performed within 3 seconds from the end of the delivery of the coffee from the spouts).

**NOTE 6:** when the 🚫 alarm comes on (chap. 12, point 1), the water tank must be filled, otherwise the coffee cannot be made. The water tank can only be removed if the milk frother is first positioned towards the centre of the machine. (It is normal for there to be a little water left in the tank when the 🚫 alarm comes on).

**NOTE 7:** : the machine counts the number of cups of coffee made. Each 14 single cups (or 7 double cups), the 📊 light switches on steady (chap. 12 point 3), warning the user that the grounds container is full and must be emptied and cleaned. Until the grounds container has been cleaned, the light will remain on and the machine cannot deliver coffee. To clean the container, open the service door on the front (pulling the handle, Fig. 15), the ⚠ light flashes (see para 12 point 9); remove the drip tray (Fig. 16), empty and clean. Empty and carefully clean the grounds container, making sure to remove all the residues that may be deposited on the bottom. Also dry the any drops of condensate that may have formed inside the machine under the drip tray. **IMPORTANT:** when removing the drip tray, the grounds container **MUST** be emptied, even if it is not completely full. If this is not done, when next making coffee the grounds container may fill over the maximum level and block the machine with lumps of coffee grounds.

**NOTE 8:** the grinder in the coffee maker may become worn over time and consequently the coffee will change taste as it is ground more coarsely. To resolve this problem, re-set the grinding coarseness on the coffee grinder by adjusting the knob (Fig. 17) one click anticlockwise (as described in chap. 6).

**NOTE 9:** if the machine is not used for a long period, the infuser must be cleaned, as described in par. 10.2.

**NOTE 10:** while the machine is delivering coffee, never remove the water tank. If it is removed, the machine will not be able to make the coffee and the "no water" light will flash. If you try and make another coffee, the machine becomes noisy and does not make the coffee. To reset the machine, turn the steam knob anticlockwise as far as it will go and run off water from the cappuccino maker for a few seconds.

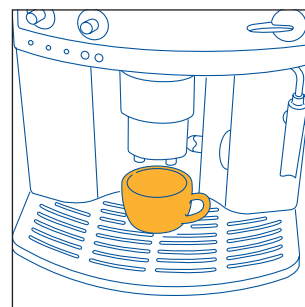

Fig. 9

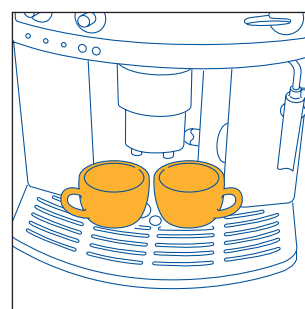

Fig. 10

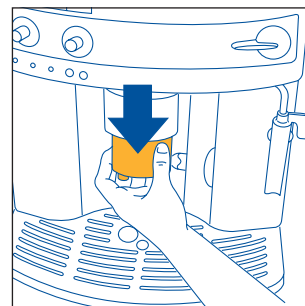

Fig. 11

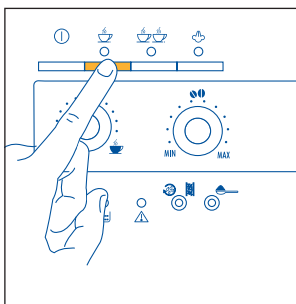

Fig. 12

When using the machine for the first time, 4-5 cups of coffee need to be made before the machine starts to give satisfying results.

When an alarm light comes on to signal an anomaly, do not contact the service centre straight away. The problems can almost always be resolved by following the instructions indicated in paragraphs 12 and 13. If necessary, contact the customer service by calling the number listed on the sheet enclosed on page 2.

If your country is not listed on the sheet, call the number indicated on the warranty.

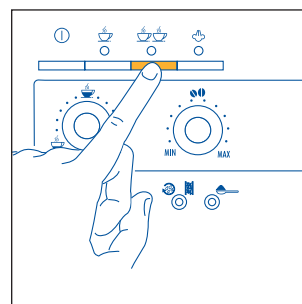

Fig. 13

## 6 ADJUSTING THE COFFEE GRINDER

The coffee grinder must not be adjusted, at least initially, as it has already been pre-set in the factory for the correct delivery of the coffee.

Nonetheless, after having made the first coffees, if delivery is too fast or too slow (in drops), the grinding coarseness must be adjusted using the knob (Fig.17) located inside the bean container. Turning one click (one number) clockwise achieves faster delivery of the coffee (without drops).

Turning one click anticlockwise achieves slower delivery **and makes the coffee creamier in appearance.**

These adjustments will only be evident after the delivery of at least 2 cups of coffee.

**The grinding coarseness adjustment knob must only be turned when the coffee grinder is on.**

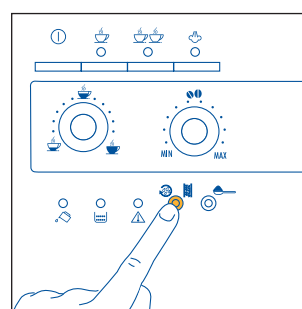

Fig. 14

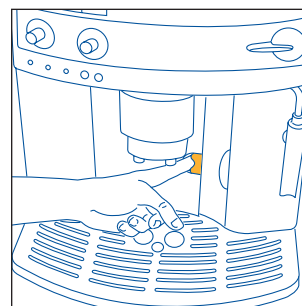
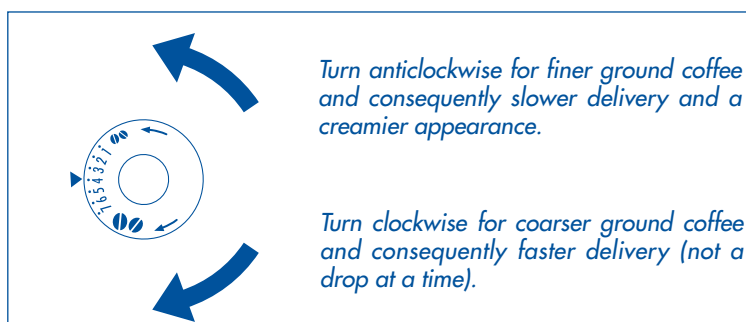

Fig. 15

**NOTE 1:** The machine has been tested in the factory using coffee and therefore it is completely normal to find some traces of coffee in the grinder. The machine is in any case guaranteed to be new.

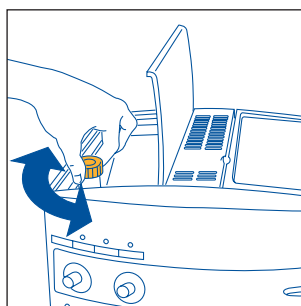

Fig. 17

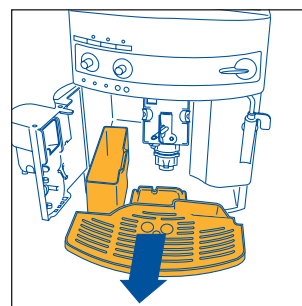

Fig. 16

## 7 PREPARING ESPRESSO COFFEE WITH GROUND COFFEE (INSTEAD OF BEANS)

1. Press the ☞ button to select the ground coffee function (Fig. 18). The light inside the button switches on to indicate that the function has been selected and the coffee grinder has been disabled.
2. Lift the lid in the centre, insert the pre-ground coffee measure in the funnel (see fig. 19) and proceed as described in paragraph 5.  
NB: You can make just one coffee at a time by pressing the ☞ button.

**NOTE 1:** Never add the ground coffee when the machine is off, to prevent it from spilling inside the machine.

**NOTE 2:** Never add more than 1 measure, otherwise either the machine will not make the coffee and the pre-ground coffee will be lost inside the machine, dirtying it, or the coffee will be run off in drips.



**NOTE 3:** When dosing the quantity of coffee to be added, only use the measure supplied.

**NOTE 4:** Only use ground coffee for espresso coffee makers: do not use coffee beans, freeze-dried coffee or other materials that may damage the machine.

**NOTE 5:** If you add more than one measure of pre-ground coffee and the funnel blocks, use a knife to push the coffee down (Fig. 20) and then remove and clean the infuser and the machine, as described in paragraph 10.2 "Cleaning the infuser".

3. Once the coffee has been delivered, to make coffee using the beans again, deactivate the ground coffee function by pressing the ☞ button again (the light goes off and the coffee grinder is enabled for operation again).

## 8 HOT WATER DELIVERY

- Always make sure that the green ☞ and ☞☞ lights are on steady.
- Turn the milk frother towards the outside of the machine (Fig. 3).
- Position a container underneath the milk frother (Fig. 3).
- Turn the steam knob half a turn in anticlockwise until it stops (Fig. 5): hot water will come out of the milk frother and start to fill the container underneath.
- To stop the flow of hot water, turn the knob all the way clockwise (Fig. 6) and return the milk frother to the original position towards the centre of the machine. (It is recommended to deliver hot water for no more than 2 minutes).

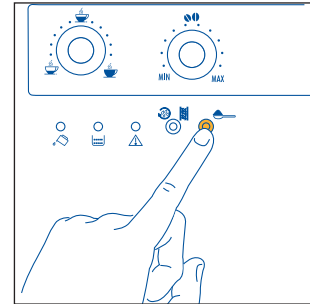

Fig.18

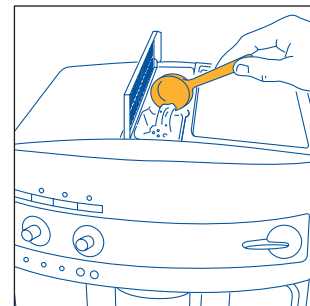

Fig.19

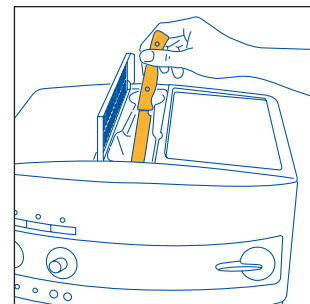

Fig.20



## 9 PREPARING CAPPUCCINOS (USING STEAM)

- Fill a container with around 100 grams of milk for each cappuccino being prepared. When choosing the size of the container, remember that the volume will increase by 2 or 3 times. **It is recommended to use partially skimmed milk at fridge temperature.**
- Move the milk frother towards the outside (Fig. 3).
- Prepare the espresso coffee as described in the previous paragraph, using sufficiently large cups.
- Then press the steam button (Fig. 21). The ☁ light (Fig. 22) starts flashing to indicate that the machine is heating up.
- When the ☁ light remains on steady and stops flashing, the temperature of the machine has reached the ideal value for making the steam (par. 11 - point 6).
- **Immediately after, within a maximum of two minutes** (otherwise the machine automatically returns to the coffee function), dip the milk frother into the container of milk (Fig. 23), making sure not to immerse the line in relief on the milk frother (indicated by the arrow in Fig. 24) and turn the steam knob half a turn anticlockwise until it stops (Fig. 5). (*Be careful, to avoid being scalded*). The steam released will make the milk froth and increase in volume. To make creamier foam, dip the milk frother into the milk and rotate the container with slow movements from the bottom to the top (you are recommended to limit steam delivery to no more than two minutes at a time).
- Once having reached the desired temperature, stop the steam by turning the steam knob clockwise until it stops (Fig. 6) and then press the steam button (Fig. 21) to deactivate the steam function ☁.
- Pour the frothed milk into the cups containing the espresso coffee prepared previously. The cappuccino is now ready (add sugar to taste and if desired, sprinkle the foam with a little cocoa powder).

**NOTE 1:** : immediately after having prepared the cappuccino, once having pressed the steam button ☁ (Fig. 21) to deactivate the function, when pressing the ☕ (Fig. 12) or ☕☕ button (Fig. 13) to make coffee again, the machine is too hot to make coffee (the green ☕ and ☕☕ lights flash to indicate that the temperature is not suitable); simply wait around ten minutes for the machine to cool down a little.

**HINT:** To cool it down more quickly, after having deactivated the steam function, open the steam knob and release some water from the milk frother into a container, until the green ☕ and ☕☕ lights stop flashing.

**NOTE 2:** The milk frother must always be cleaned after use.

Proceed as follows:

- Release a little steam for a few seconds by turning the steam knob anticlockwise until it stops (Fig. 5).

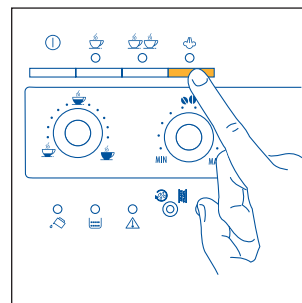

Fig.21

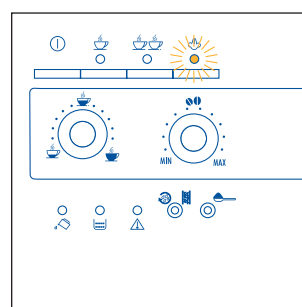

Fig.22

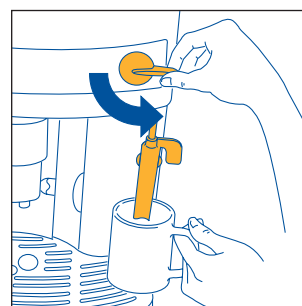

Fig.23

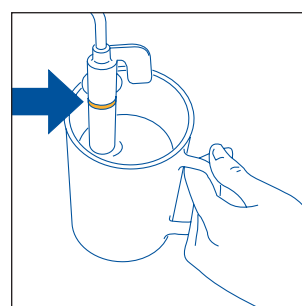

Fig.24

With this operation, the steam spout discharges any milk that may be left inside. **IMPORTANT:** For reasons of hygiene, this operation should always be performed, so as to prevent the milk from remaining in the circuits inside the milk frother.

- Turn the knob clockwise as far as it will go. With one hand, hold the cappuccino tube firm and with the other unscrew the cappuccino maker itself by rotating clockwise and extracting downwards (fig. 25).
- Remove the steam nozzle from the delivery spout by pulling it downwards (Fig. 26).
- Carefully wash the milk frother and the steam nozzle in warm water.
- Check that the two holes indicated by the arrows in Fig. 27 are not clogged. If necessary, clean them using a needle or pin.
- Replace the steam nozzle by inserting it and vigorously turning it upwards into the steam spout.
- Replace the milk frother by pushing it upwards and turning it anti-clockwise.

## 10 CLEANING AND MAINTENANCE

- Before performing any cleaning operations, the machine must have cooled down and must be disconnected from the mains power supply.
- Never immerse the machine in the water: it is an electrical appliance.
- Do not use solvents or abrasive detergents to clean the coffee maker. A soft damp cloth will suffice.
- All the components of the machine must not be washed in the dishwasher.

### 10.1 CLEANING THE COFFEE MAKER

- Clean the grounds container (as described in chapter 5, note 7) whenever the  light comes on steady (chap. 12 - point3).
- The water tank should be cleaned regularly.
- The drip tray is fitted with a level indicator (red) showing the level of water inside. When the indicator starts to become visible (a few millimetres under the drip tray), the drip tray must be emptied and cleaned.
- Check that the holes in the coffee delivery spout are not blocked. To clean them, scrape the dry coffee residues with a needle (Fig. 28).

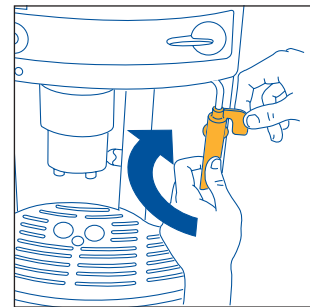

Fig.25

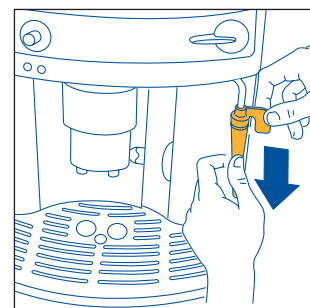

Fig.26

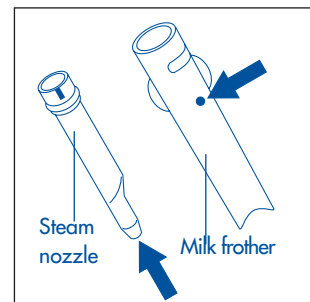

Fig.27

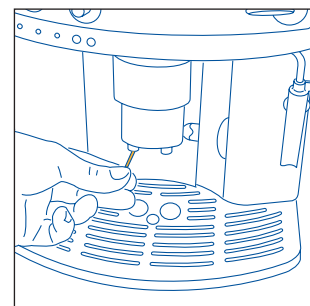



Fig.28

## 10.2 CLEANING THE INFUSER

The infuser must be cleaned regularly to prevent it from filling with coffee deposits (that may lead to malfunctions). To clean it, proceed as follows:

- turn the machine off by pressing the  button (Fig. 4) (do not unplug it) and **wait for all the indicator lights to go off**;
- open the service door (Fig. 15);
- remove the drip tray and the grounds container (Fig. 16) and clean them;
- press the two red release buttons on the infuser sideways and towards the centre (Fig. 29) and pull it out;

**WARNING: THE INFUSER CAN ONLY BE REMOVED WHEN THE MACHINE IS OFF. ATTEMPTING TO REMOVE THE INFUSER WITH THE MACHINE ON WILL RISK CAUSING DAMAGE.E.**

- wash the infuser under running water, without using detergents. Never wash the infuser in the dishwasher;
- carefully clean the inside of the machine. To remove the coffee stuck to the parts inside the machine, scrape it with a plastic or wooden fork (Fig. 30) and then pick up all the residues using a vacuum cleaner (Fig. 31);
- Replace the infuser by sliding it onto the supports and the pin at the bottom; **then push the PUSH symbol fully in until hearing the click.**

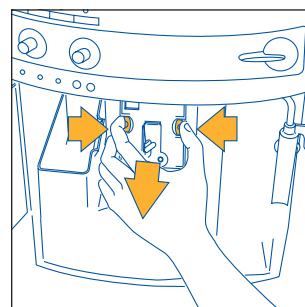

Fig.29

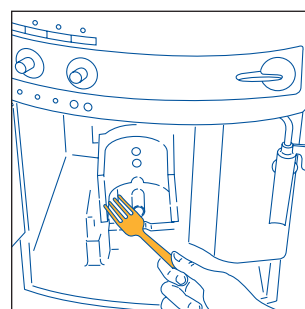

Fig.30

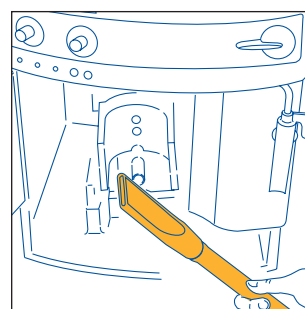
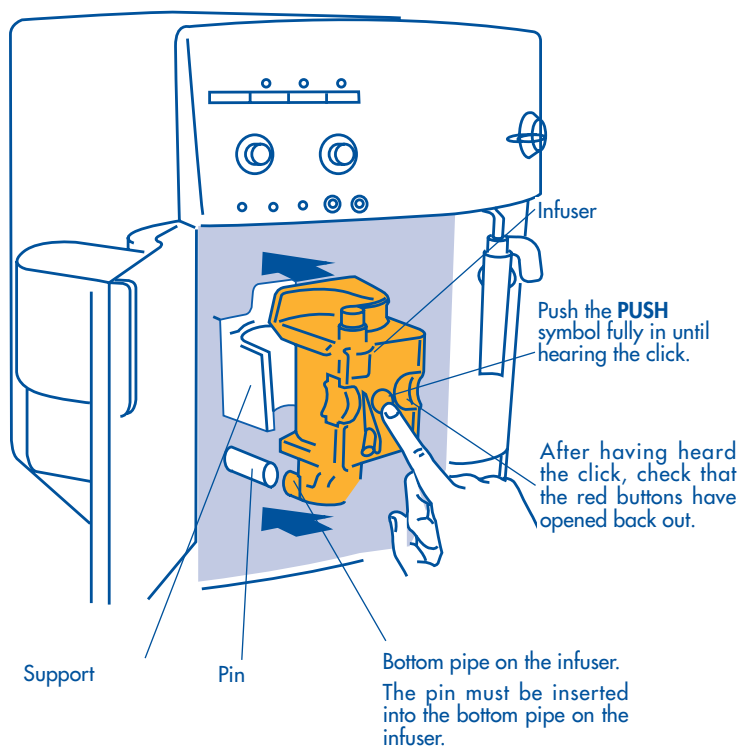
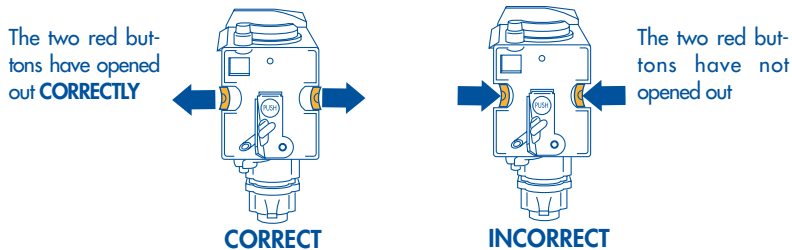

Fig.31



Check that the two red buttons have opened back out, otherwise the door cannot close.



**NOTE 1:** If the infuser is not inserted correctly until hearing the click and the two red buttons have not opened out properly, the service door will not close and the machine will not operate (when switching on the machine the  $\triangle$  light starts flashing (chap. 12 - point 9)).

**NOTE 2:** if it is hard to insert the infuser, (before inserting it) squeeze it into size by pressing it vigorously from above and below at the same time, as shown in Figure 32

**NOTE 3:** if it is still hard to insert the infuser, leave it out of the machine, close the service door, unplug from the mains then plug in again. Wait for all the lights to go off, then open the door and replace the infuser.

- replace the drip tray, complete with the grounds container;
- close the service door.

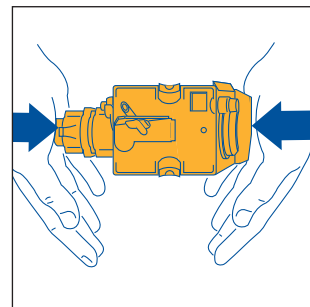

Fig.32

### 10.3 DESCALING

Due to the continuous heating of the water used to make the coffee, over time it is normal for the tubing inside the machine to fill with lime scale. When the  $\text{☉}$  light starts flashing (chap. 12-point 5), it is time to descale the machine.

**NOTE:** when the  $\text{☉}$  light switches on, the coffee maker can still be used to prepare coffee.

Proceed as follows:

- empty the water tank and add the contents of one bottle (125 ml) of DURGOL descaler plus **one litre of water**;
- place a container with a minimum capacity of 1.5 litres under the milk frother (Fig. 3);
- turn the machine on by pressing the  $\text{Ⓛ}$  button (Fig. 4).
- wait for the green  $\text{☕}$  and  $\text{☕☕}$  indicator lights to come on steady.
- press and hold the  $\text{☉}$  button for at least 5 seconds (Fig.14). The light inside the button switches on (chap. 11 - point 8) to indicate the start of the descaling program (the  $\text{☕}$  and  $\text{☕☕}$  lights remain off to indicate that it is not possible to make coffee).
- turn the steam knob half a turn anticlockwise (Fig.5). The descaling solution will come out of the milk frother and start to fill the container underneath.
- the descaling program automatically performs a series of deliveries and pauses, so as to remove the lime scale deposits from inside the coffee maker.
- after around 30 minutes, when the  $\text{☕}$  light comes on (chap. 12 - point 1), turn the steam knob half a turn clockwise (Fig.6) until it stops.

The machine must be rinsed so as to eliminate the residues of descaling solution from inside the machine. Proceed as follows:

- remove the water tank, rinse it and fill it with clean water.
- reposition the tank.
- empty the collection container (located under the milk frother) that is full of liquid, and then replace it under the milk frother.
- turn the steam knob half a turn anticlockwise (Fig. 5). Hot water will come out of the milk frother and fill the container underneath.
- when the tank is empty, the ☉ ☒ light goes off and the ☞ light comes on (chap. 12 - point 1).
- turn the steam knob all the way clockwise (Fig. 6) and fill the water tank with clean water again.
- the program of descaling is hour terminated and the machine is ready per do again the coffee.

NOTE: if the descaling procedure is stopped before completion, the ☉ ☒ alarm (chap. 12 - point 5) is not deactivated and the procedure must be started again from the beginning.

**IMPORTANT: THE GUARANTEE IS NOT VALID IF THE ABOVE DESCALING OPERATION IS NOT PERFORMED REGULARLY.**

#### 10.4 SETTING THE WATER HARDNESS























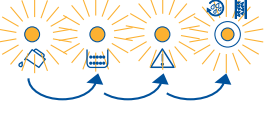

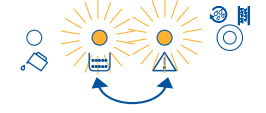

The ☉ ☒ light (chap. 12 - point 5) switches on after a preset period of operation, set in the factory, considering the maximum quantity of lime scale that may be contained in the mains water. If necessary, this period of operation can be extended, thus making the descaling operation less frequent, by programming the machine based on the actual lime content in the water used. Proceed as follows:

- after having removed the "Total hardness test" strip (enclosed on page 2) from its packaging, dip it fully in the water for a few seconds, then pull it out and wait around 30 seconds (until it changes colour and a number of red dots are formed);
- check that the machine is off (all the indicator lights are off);
- press the ☉ ☒ button (Fig. 14) and hold it for at least 5 seconds. The four lights ☞, ☒, ☒ and ☉ ☒ come on.
- press the ☞ button (Fig. 18) repeatedly until the number of lights that are on coincides with the number of red squares on the test strip (for example, if there are 3 red squares on the test strip, press the button ☞ until 3 indicator lights come on together, ☞, ☒ and ☒).
- press the ☉ ☒ button (Fig. 14) to save the data. The coffee maker is now programmed to provide the descaling warning when effectively necessary, based on the actual hardness of the water..

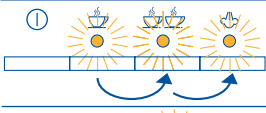
## 1.1 MEANING OF THE NORMAL OPERATION INDICATOR LIGHTS

	LIGHT	DESCRIPTION	MEANING
1		The ☕, ☕☕ indicator lights flash	The machine is not ready to make coffee (the ideal water temperature has not yet been reached). Wait for the indicator lights to come on steady before making the coffee.
2		The ☕, ☕☕ indicator lights are on steady.	The machine is at the right temperature and ready to make coffee
3		The ☕ light is on steady	The machine is delivering one cup of coffee.
4		The ☕☕ light is on steady	The machine is delivering two cups of coffee.
5		The ☁ steam light flashes	The machine is heating to the ideal temperature to produce steam. Wait for the light to come on steady before turning the steam knob.
6		The ☁ light is on steady	The machine is ready to deliver steam and the steam knob can be turned.
7		The ☕ light is on steady	The machine is ready for delivery using ground coffee (see chap. 7).
8		The ☕ light is on steady	The automatic descaling program is in progress (see par. 10.3)

## 12 MEANING OF THE ALARM INDICATOR LIGHTS AND WHAT TO DO WHEN THEY ARE ON

LIGHTS	DESCRIPTION	MEANING	ACTION
1 	The  light is on steady	The water tank is empty or is positioned incorrectly.	Fill the water tank as described in par. 5, note 6 and insert it fully.
		The tank is dirty or lined with lime scale.	Rinse or descale the tank.
2 	The  light flashes	The machine cannot make the coffee and is noisy.	Turn the steam knob anticlockwise (Fig. 5) as described in par. 5 note 10.
		The coffee comes out too slowly.	Turn the grinding adjustment knob (Fig. 17) one click clockwise (par. 6).
3 	The  light is on steady	The coffee grounds container is full or not in place.	Empty the grounds container and clean it as described in par. 5 - note 7, then insert it fully.
		The grounds container has not been replaced after cleaning.	Open the access door and replace the grounds container.
4 	The  light flashes	The ground coffee has not been poured into the funnel with the  function selected.	Add the ground coffee as described in par. 7.
		No more coffee beans	Fill the container with beans, as described in par. 4.2
		If the coffee grinder is very noisy, it means that a small stone in the coffee beans has blocked the coffee grinder.	Contact an authorised Dè Longhi service centre.
5 	The   light flashes	This indicates the presence of lime scale in the machine.	The descaling procedure, described in par. 10.3, needs to be performed as soon as possible.
6 	The machine makes a strange noise and the four lights  ,  ,  , and  flash alternately.	After cleaning, the infuser has probably been left out of the coffee maker.	Leave the service door closed and the infuser out of the coffee maker. Press the 1CUP and 2CUPS buttons together until the four lights go off. Only when all four lights are off can the door be opened and the infuser inserted (to insert the infuser see par. 10.2)
7 	The  and  lights flash alternately	The machine has just been switched on and the infuser is not inserted correctly, consequently the door is not closed properly.	Press the infuser where marked PUSH until hearing the click. Check that the two red buttons open out correctly (par. 10.2). Close the service door and press the  button.
8 	The  ,  and  lights are on and flashing	The machine has been switched on with the steam knob in the open position.	Turn the steam knob clockwise all the way round (Fig. 6).
9 	The  light is flashing	The service door is open.	If the service door cannot be closed, check that the infuser is inserted correctly (par. 10.2 - note 1)





LIGHTS		DESCRIPTION	MEANING	ACTION
10		<p>The  light is on steady and the green lights are flashing.</p>	<p>After cleaning, the infuser has probably been left out of the coffee maker</p>	<p>Insert the infuser, see par. 10.2</p>
			<p>The inside of the machine is very dirty.</p>	<p><b>Thoroughly clean the inside of the machine, as described in par. 10.2</b></p>
11		<p>The  light is flashing</p>	<p>The ground coffee funnel is clogged.</p>	<p>Empty the funnel with the help of a knife, as described in par. 7 note 5 (Fig.20).</p>

### 13 PROBLEMS THAT CAN BE RESOLVED BEFORE CALLING THE SERVICE CENTRE

If the machine is not working and an alarm light is on, the causes of the malfunction can be identified and resolved by referring to chap. 12. If, on the other hand, no alarm light is on, run the following checks before calling the service centre.

PROBLEM	CAUSE	SOLUTION
<ul style="list-style-type: none"> <li>The coffee does not come out of one of the spouts.</li> </ul>	<ul style="list-style-type: none"> <li>The cups have not been preheated.</li> </ul>	<p>Heat the cups by rinsing them in hot water or leaving them to rest for at least 15 minutes on the cup warmer tray on the lid (see par. 5 note 3).</p>
	<ul style="list-style-type: none"> <li>The infuser is too cold</li> </ul>	<p>Heat the infuser by pressing the  button before making the coffee (Fig. 14, see note 3, chapter 5).</p>
<ul style="list-style-type: none"> <li>The coffee is not creamy enough</li> </ul>	<ul style="list-style-type: none"> <li>The machine uses too little coffee during the infusion process.</li> </ul>	<p>Turn the right-hand knob (Fig. 7) a little clockwise (see chap. 5 note 2)</p>
	<ul style="list-style-type: none"> <li>The coffee is ground too coarse</li> </ul>	<p>Turn the grinding adjustment knob (Fig. 17) one click anticlockwise (see chap. 6).</p>
	<ul style="list-style-type: none"> <li>The ground coffee is not correct</li> </ul>	<p>Use another brand of coffee blend.</p>
<ul style="list-style-type: none"> <li>The coffee comes out too slowly</li> </ul>	<ul style="list-style-type: none"> <li>The coffee is ground too fine.</li> </ul>	<p>Turn the grinding adjustment knob (Fig. 17) one click clockwise (see chap. 6).</p>
	<ul style="list-style-type: none"> <li>The machine uses too much coffee during the infusion process</li> </ul>	<p>Turn the right-hand knob (Fig. 7) a little anticlockwise.</p>
<ul style="list-style-type: none"> <li>The coffee comes out too quickly.</li> </ul>	<ul style="list-style-type: none"> <li>The coffee is ground too coarse</li> </ul>	<p>Turn the grinding adjustment knob (Fig. 17) one click anticlockwise (see chap. 6).</p>
	<ul style="list-style-type: none"> <li>The machine uses too little coffee during infusion.</li> </ul>	<p>Turn the right-hand knob (Fig. 7) a little clockwise.</p>



PROBLEM	CAUSE	SOLUTION
<ul style="list-style-type: none"> <li>The coffee does not come out of one of the spouts.</li> </ul>	<ul style="list-style-type: none"> <li>The outlet is blocked</li> </ul>	Scrape the remains of dry coffee accumulated with a needle (Fig. 28).
<ul style="list-style-type: none"> <li>Turning the steam knob, no steam comes out of the milk frother.</li> </ul>	<ul style="list-style-type: none"> <li>The holes in the spouts are clogged.</li> </ul>	Clean the holes in the milk frother and the steam nozzle (see chap. 9 - Fig.27).
<ul style="list-style-type: none"> <li>Pressing the  and  buttons, the machine does not deliver coffee, but only water.</li> </ul>	<ul style="list-style-type: none"> <li>Ground coffee may be blocked in the funnel.</li> </ul>	Remove the ground coffee inside the funnel, using a knife (see chap. 7 - note 5). Then clean the infuser and the inside of the machine (see the description in par. 10.2)
<ul style="list-style-type: none"> <li>Pressing the  button, the machine does not switch on.</li> </ul>	<ul style="list-style-type: none"> <li>The machine is not plugged in.</li> </ul>	Check that the power cable is plugged into the power outlet
<ul style="list-style-type: none"> <li>The infuser cannot be removed for cleaning.</li> </ul>	<ul style="list-style-type: none"> <li>The machine is on. The infuser can only be removed if the machine is off</li> </ul>	Turn the machine off (see par. 10.2). <b>WARNING:</b> the infuser can only be removed when the machine is off. Attempting to remove the infuser with the machine on will risk causing damage.
<ul style="list-style-type: none"> <li>Ground coffee is used (rather than beans) and the machine does not deliver the coffee.</li> </ul>	<ul style="list-style-type: none"> <li>Too much ground coffee has been added.</li> </ul>	Remove the infuser and thoroughly clean the inside of the machine, as described in par. 10.2. Repeat the operation using a maximum of 1 level measure of ground coffee
	<ul style="list-style-type: none"> <li>The  button has not been pressed and the machine has used both the ground coffee added and the coffee ground by the grinder.</li> </ul>	Thoroughly clean the inside of the machine, as described in par. 10.2. Repeat the operation by first pressing the  button, as indicated in chapter 7.
	<ul style="list-style-type: none"> <li>Ground coffee has been added when the machine is off.</li> </ul>	Remove the infuser and thoroughly clean the inside of the machine, as described in par. 10.2. Repeat the operation, however switching on the machine first.
<ul style="list-style-type: none"> <li>The coffee does not come out of the spouts, but rather around the service door.</li> </ul>	<ul style="list-style-type: none"> <li>The holes in the spouts are clogged with dry coffee.</li> </ul>	Scrape the holes with a needle (see par. 10.1, Fig. 28).
	<ul style="list-style-type: none"> <li>The mobile drawer inside the service door is blocked and cannot swing.</li> </ul>	Thoroughly clean the mobile drawer, above all near the hinges, so that they swing smoothly.